

1. The connection of brake unit and inverter (380VAC)

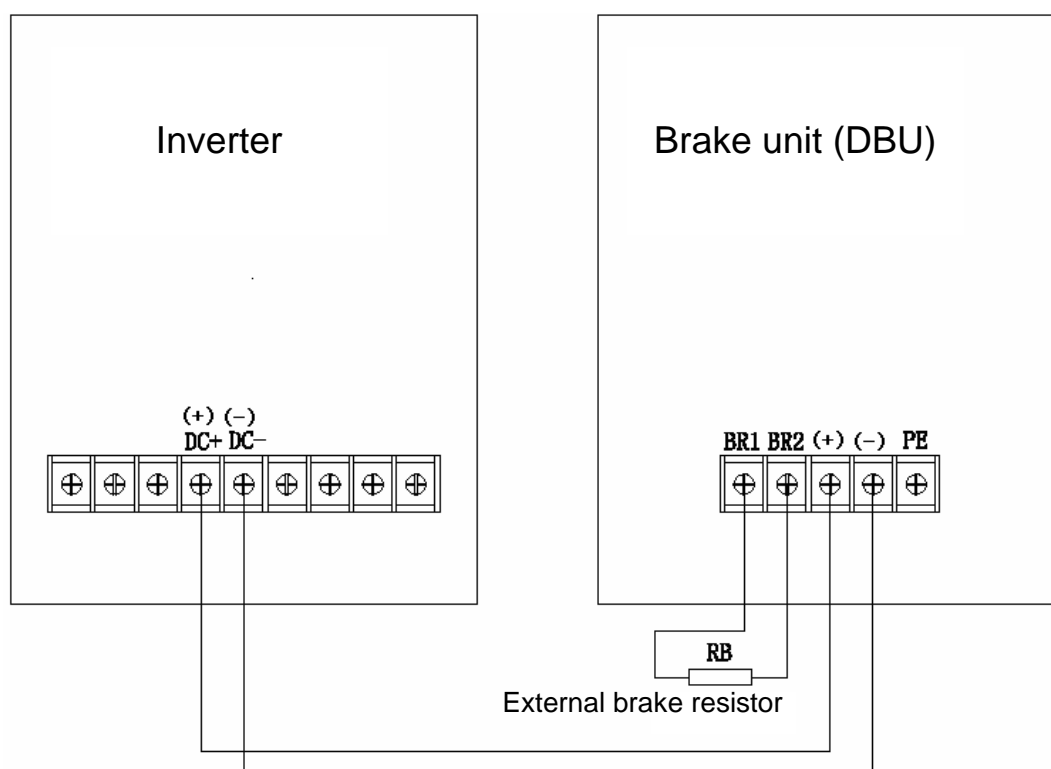

Figure 1. The connection of brake unit and inverter (380VAC).

Notice:

- (1)、The Length of the line between inverter and brake unit should be less than 5m.
- (2)、The length of the line between brake resistor and brake unit should be less than 10m.
- (3)、DC+ and DC- are “+” and “-” terminal of bus line.
- (4)、The continually brake time of brake unit can be 5 minutes. Thus the temperature of external shell will be higher, so please do not touch by hand.

2. The main circuit terminal of brake unit:

BR1	BR2	(+)	(-)	PE
-----	-----	-----	-----	----

BR1、BR2-----External brake resistor terminal.

(+)------Positive terminal of inverter bus line.

(-) ----- Negative terminal of inverter bus line.

PE-----Ground terminal

3. The main control terminal of brake unit:

Rst	EFI	PI	COM	PO1	PO2
-----	-----	----	-----	-----	-----

ROA	ROB	ROC
-----	-----	-----

Connection terminal	Terminal	Description
	RST	External reset terminal. When some trouble with brake unit, can short connect this terminal and “COM” to reset.
	EFI	External fault input terminal. When fault, the brake unit will output fault signal.
	PI	Parallel input terminal. When several brake units are parallel, can use this terminal to monitor the operation status of other brake units.
	COM	The common terminal of RST、EFI and PI.
	PO1 PO2	Parallel output terminal. Output signal.
	ROA ROB ROC	Fault input terminal. When fault, the fault relay will output fault warning signal. ROA—ROB always close, ROA—ROC always open

When one brake unit, please refer to Figure 1. After finish connecting the inverter, brake unit and brake resistor, setting the voltage class and braking threshold, the brake unit will be started to operate.

4. Voltage setting:

Different input voltage of inverter needs different voltage selection setting of brake unit. Please notice that when select voltage, the power has to be cut off.

The following is the relation of voltage selection setting and the start braking voltage:

Notice:

(1)、If the bus line voltage is higher than 20% of normal, please set the bigger brake voltage.

(2)、The start brake voltage of inverter should be match with that of brake unit.

Warning

Do not operate when power on!















No.	S1 selection		220V		380V		690V		1140V	
	50% braking rate	100% braking rate	Braking start value (V)	Braking stop value (V)	Braking start value (V)	Braking stop value (V)	Braking start value (V)	Braking stop value (V)	Braking start value (V)	Braking stop value (V)
0			330	320	640	620	1080	1060	1950	1920
1			350	340	660	640	1100	1080	2000	1970
2	 (Factory setting)		370	360	680	660	1120	1100	2050	2020
3			380	370	700	680	1140	1120	2100	2070
4			390	380	720	700	1160	1140	2150	2120
5			400	390	740	720	1180	1160	2200	2170
6			Reserved	Reserved	Reserved	Reserved	Reserved	Reserved	Reserved	Reserved
7			Parallel operation	Parallel operation	Parallel operation	Parallel operation	Parallel operation	Parallel operation	Parallel operation	Parallel operation

Figure 2. The relation of voltage selection setting and the start braking voltage.

5. Parallel operation

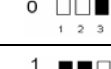
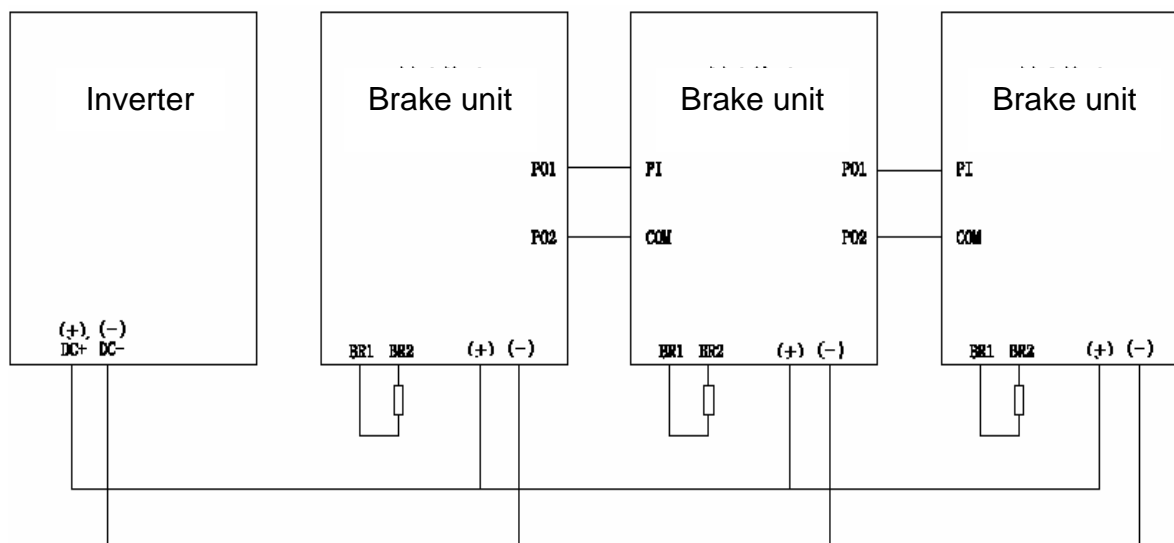

Figure 3. Parallel connection of brake unit an inverter (380V).

Control terminal wiring description:

When parallel connect several brake unit, can set the first one to be host, others are slave. The parameters setting, please refer to the last item of Figure

Notice: The braking rate of host and slave should to be consistent.

Connection:

Connect the output terminal PO1, PO2 of the first brake unit with the input terminal PI, COM of the second brake unit. The same with other brake unit.

6. Trouble shoot

No.	Fault type	Reason	Solution
1	Higher heating of brake resistor when braking	Too small power of brake resistor	Replace the bigger power of brake resistor
2	Higher heating of brake resistor without braking	Damage of IGBT	Replace with the new brake unit
		Voltage setting of brake unit is not correct	Resetting
		Fault with brake unit	Replace with the new brake unit
3	Over-voltage with inverter (OU)	Not so enough braking	Check the brake condition
		Wrong wiring	Check and modify
		Voltage setting of brake unit is not correct	Resetting
		Fault with brake unit	Replace with the new brake unit
4	Relay output fault signal	Valid of external fault input	Check the operation condition
		Too high brake current, too small brake resistor	Select the bigger brake resistor
		Too long braking time	Decrease the braking frequency
		Fault with internal power	Replace with the new brake unit

7. Extension dimension

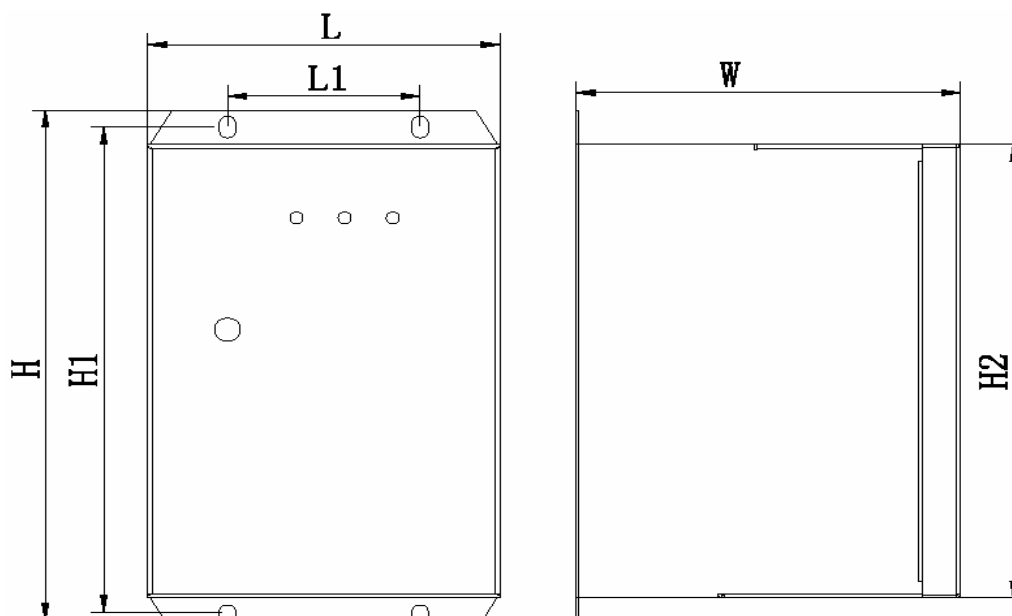

Unit: mm

MODEL	Inverter Power	L	L1	W	H	H1	H2
DBU-055-2	11-55KW	110	60	120	180	171	160
DBU-055-4	18.5-55KW	110	60	120	180	171	160
DBU-315-4	132-315KW	180	120	164	285	277	260